

ÿ ž ž ž

COD

fTPHĒ

Sorur.Safa@gmail.com

lÿ /ÿ :

lÿ /ÿ :

fTPHĒ

fPAHĒ

ÿ

fV ÇÇĒ

UV

pH iH₂O₂

éL

pH iH₂O₂

COD

pH=é ÿ / M

ÿ / mM

COD ñ / ž

UV

žH

pH

h

UV

COD

fPH= E

ž

UV/Fe²⁺/H₂O₂

ÿ

fTPHĒ

!è

!é

!è

!

!

۳۰ min
 pH
 M NaOH
 pH
 H₂O₂
 COD
 COD
 pH
 H₂O₂
 pH < ۳
 DR5000
 COD
 COD = (A - B) × 1000 / V
 TPH
 HACH COD
 HACH COD
 DR5000
 Excel
 COD

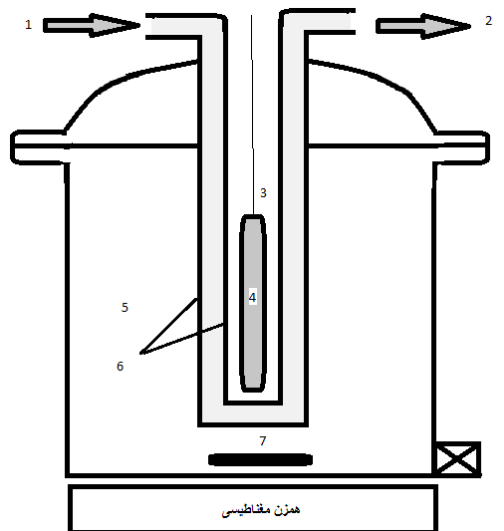

۱: ورودی، ۲: خروجی، ۳: لوله مرکزی، ۴: کاتالیست، ۵: همزن، ۶: دریچه شناور، ۷: همزن مغناطیسی، ۸: دریچه تخلیه

UV/Fe/H₂O₂
 mM FeSO₄.7H₂O
 pH= M H₂O₂
 UV H₂O₂ (L

m M COD UV UV
 % /
 f)
 ñ /
 m M
 مجزای UV، % بوده است.

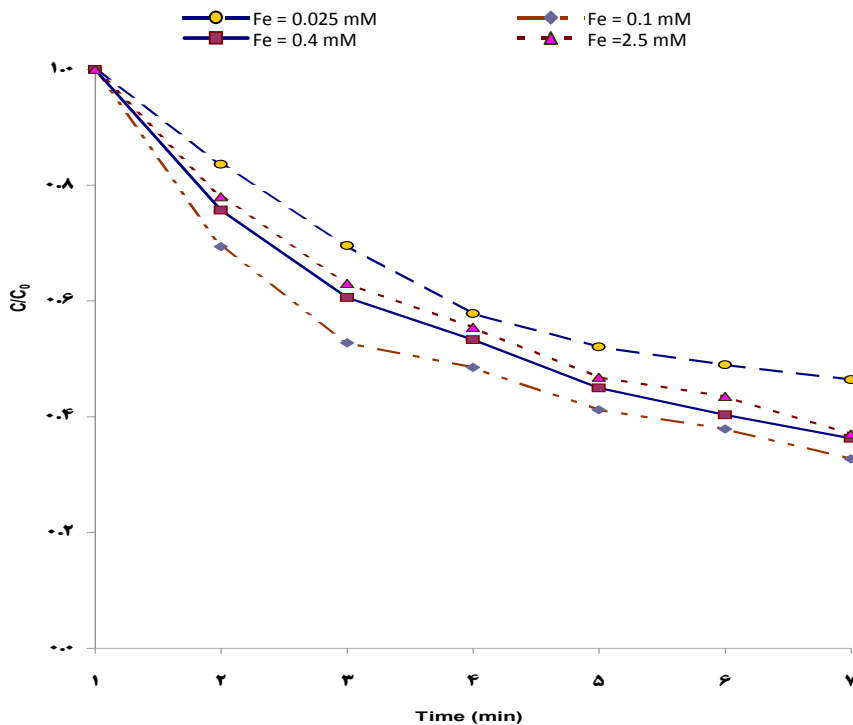

UV/Fe/H₂O₂ COD
 (UV= w iH₂O₂= i/ mol pH= , COD₀ = - y mg/L)

$\dot{y} / m M$ H_2O_2 " " / m M
 \dot{y} / mol " \dot{n}
 \dot{e} pH H_2O_2
 pH " $\dot{y} \cdot \dot{e}$ H_2O_2
 pH μ UV/Fe/ H_2O_2
 $\dot{y} M_i NaOH$ \dot{y} " "
 UV H_2O_2 " $\dot{y} / m \mu$
 COD " $\dot{y} / \dot{y} / \dot{y} / \mu$ H_2O_2 "
 pH \dot{y} / μ H_2O_2 $\dot{y} / \mu m$ H_2O_2 "
 $\dot{n} /$ " $pH =$
 $(pH =)$ H_2O_2 " "
 $(\dot{E}$ " UV
 $UV/Fe/$ COD $\dot{y} / m \mu \dot{E}$ COD
 H_2O_2 $\dot{n} /$ $H_2O_2 \dot{y} / mol$
 $(\dot{E}$ "
 pH
 min COD $1/C$ UV/ pH
 \dot{y} pH Fe/H_2O_2

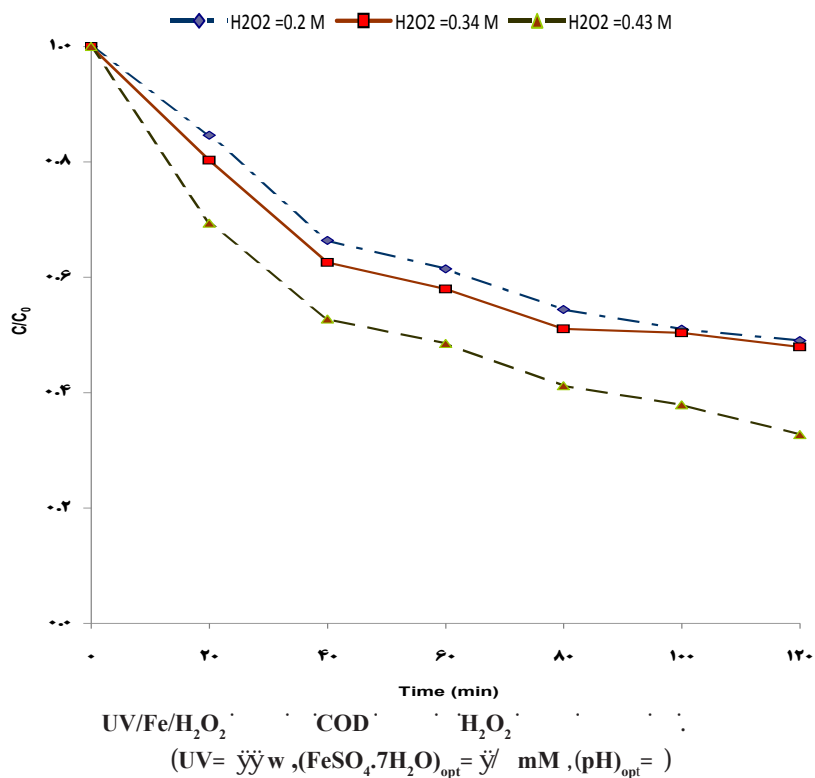

$\ln(C/C_0)$

$n /$

n

UV Fe(II)

$Fe^{+2} + H_2O_2 \rightarrow Fe^{+3} + OH^- + HO^0$

(HO⁰ Fe(II) UV

H_2O_2 Fe(II) Fe(II)

COD Fe(II)

H_2O_2

H_2O_2 COD

H_2O_2 mM COD

H_2O_2

H_2O_2

(mM

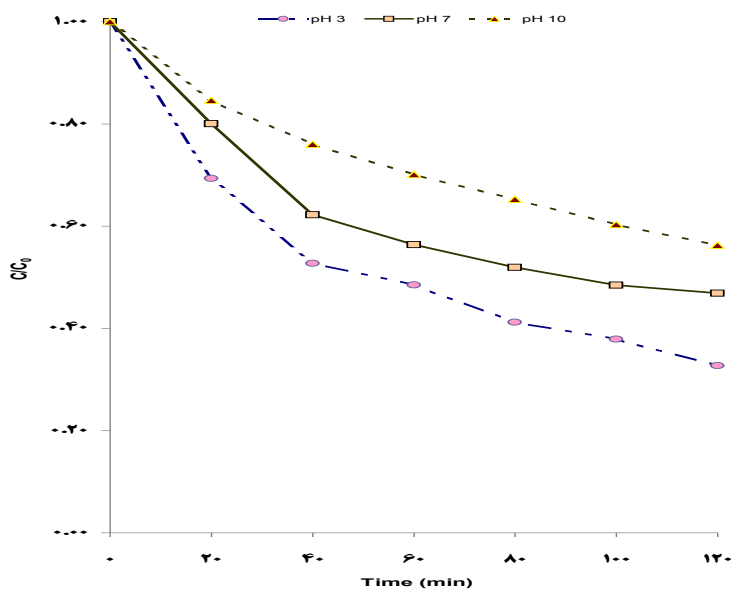

UV/Fe/H₂O₂ COD pH

(UV= μW , $(FeSO_4 \cdot 7H_2O)_{opt} = \mu\text{M}$, $(H_2O_2)_{opt} = \mu\text{mol}$)

h BTX

\dot{y} mM i Fe²⁺ \dot{y} mM i H₂O₂ $\text{HO}^0 + \text{H}_2\text{O}_2 \rightarrow \text{H}_2\text{O} + \text{HO}^0_2$

Oswaldo "fl L ñ $2\text{HO}^0_2 \rightarrow \text{H}_2\text{O}_2 + \text{O}^0_2$

Chiavone-Filho

\dot{y}

- \dot{y} mM H₂O₂ " "

\dot{y} mM - \dot{y} mM

\dot{y} Mm " :

ñ COD ñ / " "

pH "fl L " "

pH pH " "

! " "

pH COD

UV "

! " \dot{y} Kang Hua

H₂O₂ pH

" H₂O₂ pH= \dot{y}

\dot{y} Raquel F. PupoNogueira BTX

i mM i Fe²⁺ "

TritonX-100 (TX- \dot{y} L \dot{y} \dot{y} i mM i H₂O₂ \dot{y}

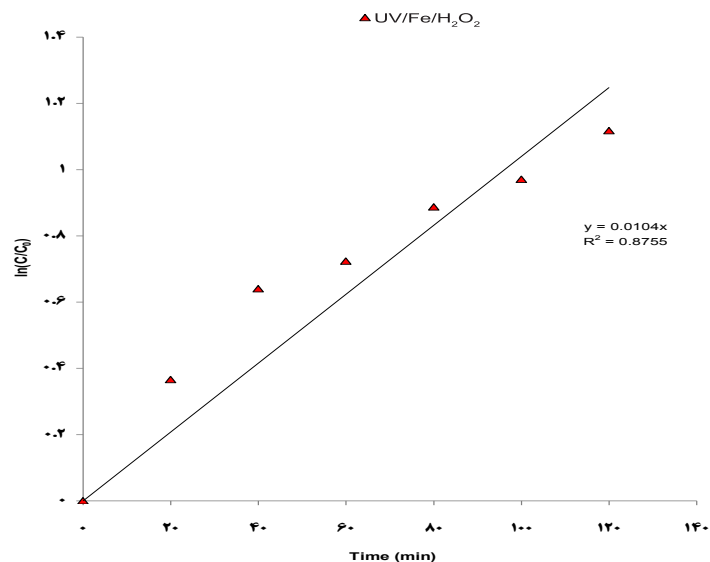

UV/Fe/H₂O₂ COD

(UV= \dot{y} w , (FeSO₄.7H₂O)_{opt}= \dot{y} μ , (H₂O₂)_{opt}= \dot{y} mol , (pH)_{opt}=)

$$\frac{1}{C} - \frac{1}{C_0} = k.t$$
 COD
 Farrokhi

$$\frac{1}{C} - \frac{1}{C_0} = k.t$$
 COD
 Farrokhi

pH
 PupoNogueira
 J. Watts
 BTX
 Kavitha Palanivelu
 Farrokhi
 TCP
 Farrokhi

COD
 pH=

pH
 UV
 TPH
 Osvaldo
 UV
 COD

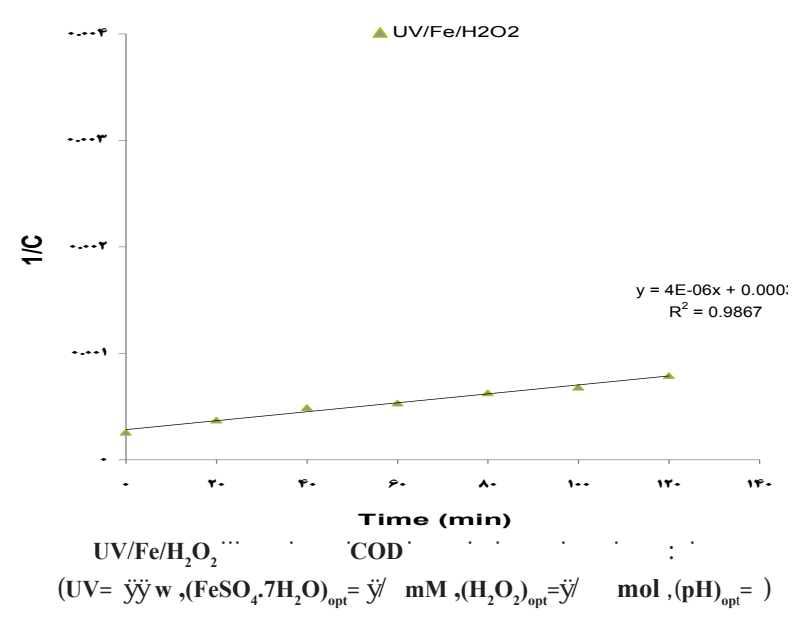

1. Todd GD, Chessin RL, Colman J. Toxicological profile for total petroleum hydrocarbons (TPH). Georgia: U.S. Department of health and human services. Public Health Service. Agency for Toxic Substances and Disease Registry; 1999 Sep.
2. Flotron V, Delteil C, Padellec Y, Camel V. Removal of sorbed polycyclic aromatic hydrocarbons from soil, sludge and sediment samples using the Fenton's reagent process. *Chemosphere*. 2005;59:1427-37.
3. Mouton J, Mercier G, Blais JF. Amphoteric surfactants for PAH and lead polluted- soil treatment using flotation. *Water, Air, and Soil Pollution*. 2009;197(1-4):381-93.
4. Feng D, Lorenzen L, Aldrich C, Mare' PW. Ex situ diesel contaminated soil washing with mechanical methods. *Minerals Engineering*. 2001;14(9):1093-100.
5. Chu W, Chan KH. The mechanism of the surfactant-aided soil washing system for hydrophobic and partial hydrophobic organics. *Science of The Total Environment*. 2003;307(1-3):83-92.
6. Fabbri D, Prevot AB, Zelano V, Ginepro M, Pramauro E. Removal and degradation of aromatic compounds from a highly polluted site by coupling soil washing with photocatalysis. *Chemosphere*. 2008;71(1):59-65.
7. Lee M, Kang H, Do W. Application of nonionic surfactant-enhanced in situ flushing to a diesel contaminated site. *Water Research*. 2005;39:139-46.
8. Chou DK, Krishnamurthy R, Randolph TW, Carpenter JF, Manning MC. Effects of Tween 20 and Tween 80 on the stability of Albutropin during agitation. *Journal of Pharmaceutical Sciences*. 2005;94(6):1368-81.
9. Daneshvar N, Aber S, Vatanpour V, Rasoulifard MH. Electro-Fenton treatment of dye solution containing Orange II: Influence of operational parameters. *Journal of Electroanalytical Chemistry*. 2008;615(2):165-74.
10. Wang J, Sun W, Zhang Z, Jiang Z, Wang X, Xu R, et al. Preparation of Fe-doped mixed crystal TiO2 catalyst and investigation of its sonocatalytic activity during degradation of azo fuchsine under ultrasonic irradiation. *Journal of Colloid and Interface Science*.

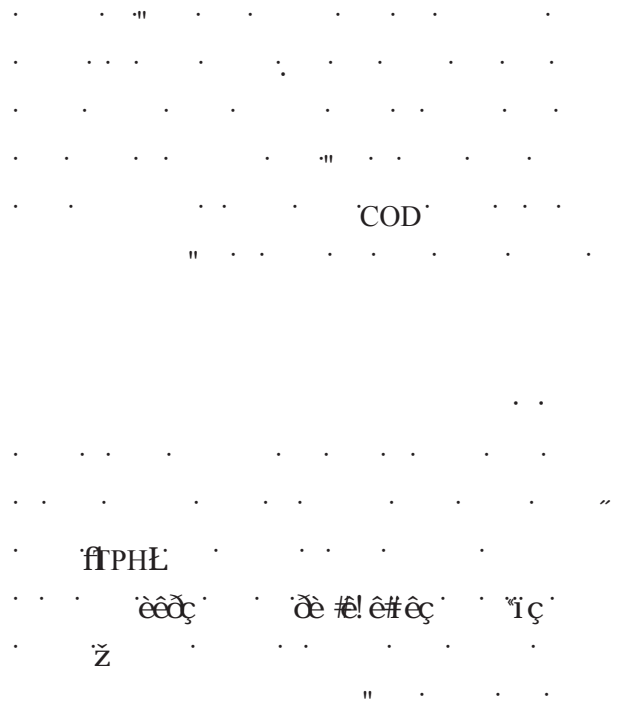

- 2008;320(1):202-9.
11. Zhang G, Yang F, Liu L. Comparative study of Fe²⁺/H₂O₂ and Fe³⁺/H₂O₂ electro-oxidation systems in the degradation of amaranth using anthraquinone/polypyrrole composite film modified graphite cathode. *Journal of Electroanalytical Chemistry*. 2009;632:154-61.
 12. Han DH, Cha SY, Yang HY. Improvement of oxidative decomposition of aqueous phenol by microwave irradiation in UV/H₂O₂ process and kinetic study. *Water Research*. 2004;38(11):2782-90.
 13. Villa RD, Trovo AG, Pupo Nogueira RF. Soil remediation using a coupled process: Soil washing with surfactant followed by photo-Fenton oxidation. *Journal of Hazardous Materials*. 2010;174:770-5.
 14. Esplugas S, Gimenez J, Contreras S, Pascual E, Rodriguez M. Comparison of different advanced oxidation processes for phenol degradation. *Water Research*. 2002;36(4):1034-42.
 15. Stepnowski P, Siedlecka EM, Behrend P, Jastorff B. Enhanced photo-degradation of contaminants in petroleum refinery wastewater. *Water Research*. 2002;36:2167-72.
 16. Tsai TT, Sah J, Kao CM. Application of iron electrode corrosion enhanced electrokinetic-Fenton oxidation to remediate diesel contaminated soils: A laboratory feasibility study. *Journal of Hydrology*. 2010;380:4-13.
 17. Tsai TT, Kao CM. Treatment of petroleum-hydrocarbon contaminated soils using hydrogen peroxide oxidation catalyzed by waste basic oxygen furnace slag. *Journal of Hazardous Materials*. 2009;170:466-72.
 18. Villa RD, Trovo AG, Pupo Nogueira RF. Environmental implications of soil remediation using the Fenton process. *Chemosphere*. 2008;71:43-50.
 19. Tchobanoglous G, Burton FL, Stensel HD. *Wastewater Engineering: Treatment and Reuse*. 4th ed. New York: McGraw-Hill; 2003.
 20. Ghaly MY, Härtel G, Mayer R, Hasender R. Photochemical oxidation of p-chlorophenol by UV/H₂O₂ and photo-Fenton process: A comparative study. *Waste Management*. 2001;21(1):41-7.
 21. Galvão SAO, Mota ALN, Silva DN, Moraes JEF, Nascimento CAO, Chiavone-Filho O. Application of the photo-Fenton process to the treatment of wastewaters contaminated with diesel. *Science of The Total Environment*. 2006;367:42-9.
 22. Chu W. Modeling the quantum yields of herbicide 2,4-D decay in UV/H₂O₂ process. *Chemosphere*. 2001;44(5):935-41.
 23. Kang N, Hua I. Enhanced chemical oxidation of aromatic hydrocarbons in soil systems. *Chemosphere*. 2005;61(7):909-22.
 24. Watts RJ, Haller DR, Jones AP, Teel AL. A foundation for the risk-based treatment of gasoline-contaminated soils using modified Fenton's reactions. *Journal of Hazardous Materials*. 2000;76(1):73-89.
 25. Kavitha V, Palanivelu K. Degradation of nitrophenols by Fenton and photo-Fenton processes. *Journal of Photochemistry and Photobiology A: Chemistry*. 2005;170(1):83-95.
 26. Farrokhi M, Mesdaghinia A, Yazdanbakhsh AR, Nasser S. Characteristic of Fenton's oxidation of 2,4,6 Trichlorophenol. *Iranian Journal of Environmental Health Science & Engineering*. 2004;1(1):12-8.

Application of Photo-Fenton Process for COD Removal from Wastewater Produced from Surfactant-Washed Oil-Contaminated (TPH) Soils

Mohammad Reza Mehrasbi¹, *Sorur Safa¹, Amir Hossein Mahvi², Ali Assadi¹, Hamed Mohammadi¹

¹Department of Environmental Health, Faculty of Health, Zanjan University of Medical Sciences, Zanjan, Iran

²Department of Environmental Health, Faculty of Health, Tehran University of Medical Sciences, Tehran, Iran

Received; 24 April 2012 Accepted; 22 July 2012

ABSTRACT

Background and Objective: The base structure of total petroleum hydrocarbons (TPH) is made of hydrogen and carbon. Widespread use, improper disposal and accidental spills of this compounds lead to long term remaining of contaminations such as organic solvents and poly aromatic hydrocarbons (PAHs) in the soil and groundwater resources, resulting in critical environmental issues. In this study, an oil-contaminated soil was washed using Tween 80 surfactant and the application of photo-Fenton process (UV/Fe²⁺/H₂O₂) for treatment of the produced wastewater was evaluated.

Materials and Methods: Tween 80 is a yellow liquid with high viscosity and soluble in water. In order to determine of the photo-Fenton process efficiency, we studied effective variables including Fe concentration, pH, H₂O₂ concentration, and irradiation time. The UV irradiation source was a medium-pressure mercury vapor lamp (400 w) vertically immersed in the solution within 2 L volume glass cylindrical reactor.

Results: The results showed that efficiency of COD removal depends on the initial Fe concentration, pH, H₂O₂ concentration and irradiation time.

Under optimum conditions, (Fe: 0.1 mM, H₂O₂: 0.43 mM, pH: 3 and UV light irradiation time: 2 hours) the removal efficiency of COD was 67.3%. pH plays a crucial role in the photo-Fenton process such that the removal efficiency increased with decreasing of pH.

Conclusion: According to the results of this study, under acidic condition, this process is an efficient method for COD removal from the wastewater studied.

Keywords: Total Petroleum Hydrocarbon (TPH), Tween 80, Advanced oxidation, UV/Fe²⁺/H₂O₂ process

*Corresponding Author: Sorur.Safa@gmail.com

Tel: +98 241 7273128, Fax: +98 241 7273153